

Article number: 203180M20199B4W

Description: E+G levelling foot  
GN 31-80-M20-199-B4-W

Note: W With adjustable sleeve , Hygienic Version, Wrench flat at the bottom

## Measures

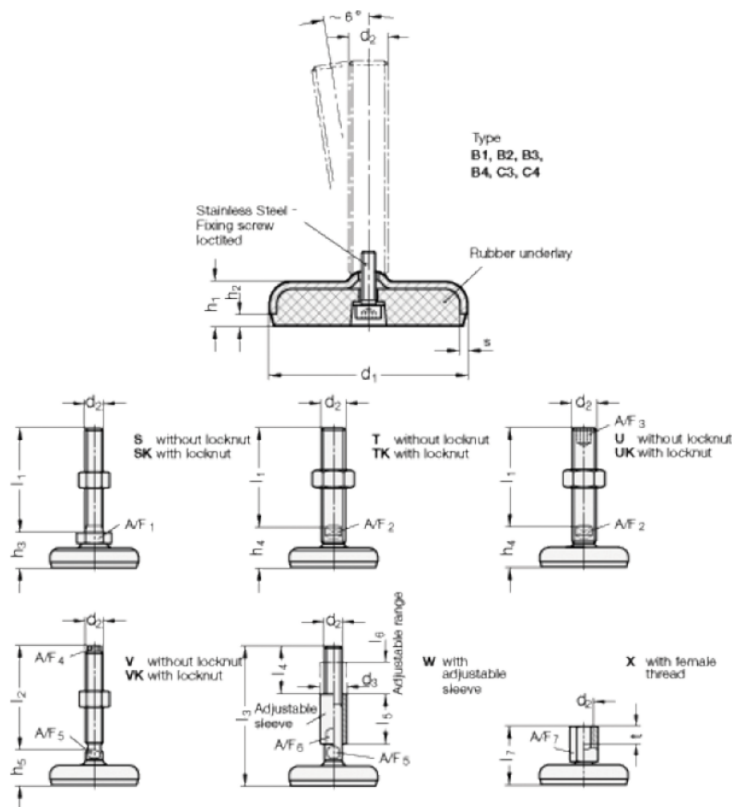

A/F5 = 16	l3 +4.0/0 = 199
A/F6 = 24	l4 = 56
d1 = 80	l5 = 56
d2 = 20	l6 = 36
d3 = 30	s = 3
h1 = 18	
h2 = 5	
l1 = 199	